



OPERATING INSTRUCTIONS

V-20 SERIES VARIAC®

Pronounced "VARY-ACK". Trade Mark Registered

Know your VARIAC! These instructions are to help you get better results with less trouble.

MECHANICAL SPECIFICATIONS

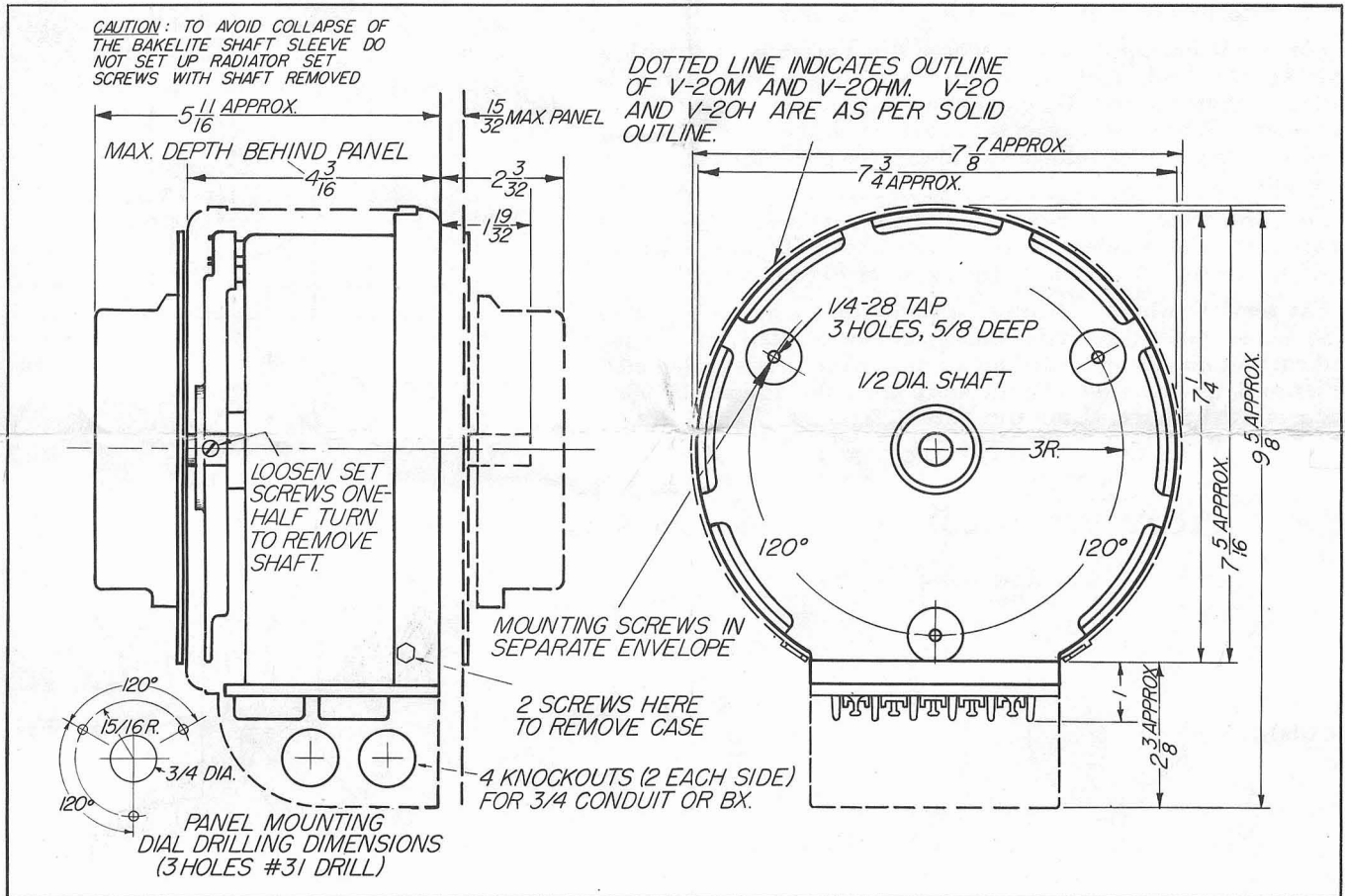

NET WEIGHTS

TYPE V-20	21 lbs., 4 oz.
TYPE V-20H	20 lbs.
TYPE V-20M	22 lbs., 4 oz.
TYPE V-20HM	21 lbs.

DIALS

Dials are normally supplied for overvoltage operation, Figures 4, 6, 7, and 9. Dials for line voltage limit operation are available on special order. Dials are two-sided to permit either dial or pointer rotation, clockwise voltage increase being the rule in both cases. Pointers are provided on knobs, permitting fixed dial and moving pointer operation for panel mounting.

The Type V-20 Variac is listed under the Re-Examination Service of the Underwriters' Laboratories, Inc. for installation in other equipment where the acceptability of the combination has been determined by the Laboratories.

FOR BEST COOLING OPERATE PANEL-MOUNTED UNITS WITHOUT CASE!

ELECTRICAL SPECIFICATIONS

V-20 TYPES		V-20H TYPES		
20	Rated Output Amperes	8	4	8
26	Max. Output Amperes	10.4	10.4	10.4
115	Input Volts	230	115	115
50,60	Cycles Per Second	50,60	50,60	25*
0-135	Output Volts	0-270	0-270	0-135
27	No Load Watts	27	27	27
3	KVA	2.4		1.2

*The V-20H may be used on 115 volts, 25 cycles. Connections should be as for 230 volts, 60 cycles, but output volts will be one-half 230-volt connection.

The current that may be drawn from a Variac depends, largely, on the use to which the Variac is put.

1. For general laboratory use, where the Variac is to be used to control a variety of loads under experimental conditions, it is safest to stay within *rated* current at all times and for all settings. If fuse protection is desired, fuse for rated current.
2. For particular applications, where the Variac is used with a fixed, known load, and where the overvoltage connection is omitted (Figures 5 and 8), maximum current may be drawn at line voltage. When the Variac is so connected, the current fall-off with decreasing output voltage will always keep the current within safe limits.
3. For continuous 24-hour-per-day duty, rated current should not be exceeded. For ambient temperatures above 50°C., the Variac should be derated according to the curve of Figure 2.
4. For services where an initial surge current may be expected (as in motor starting, incandescent lamp control, etc.), the Variac rated current may be exceeded on a time-current basis as depicted in Figure 3. At no time should more than ten times (1000%) rated current be drawn from the Variac.

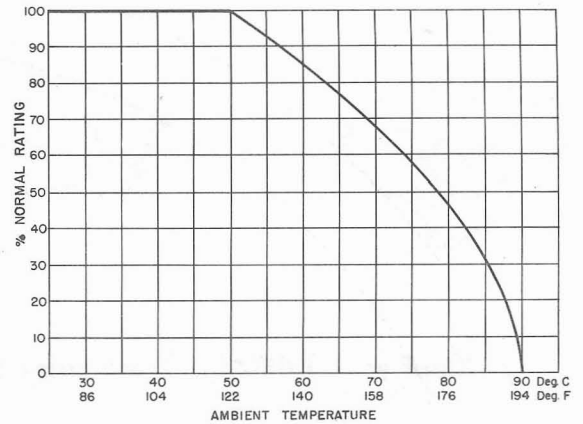

Figure 2

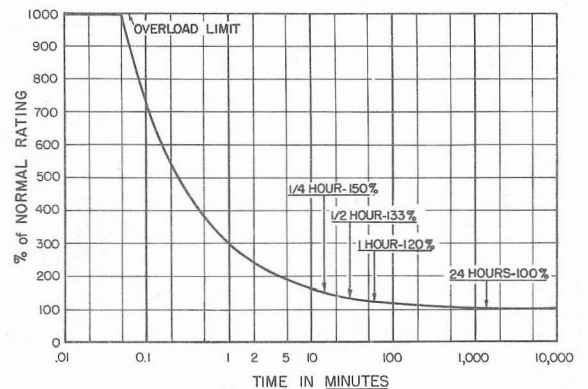

Figure 3

RECOMMENDED CONNECTIONS are diagrammed in Figures 4 to 9 inclusive.

TABLE MOUNTING

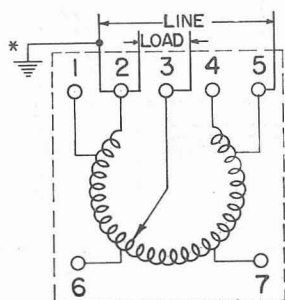

FIGURE 4

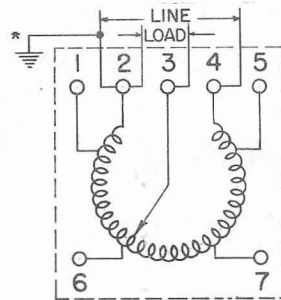

FIGURE 5

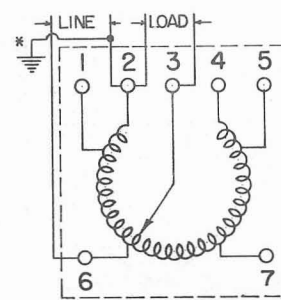

FIGURE 6

TABLE MOUNTING

V-20 { LINE: 115 volts, 50 to 60 cycles
LOAD: 0-135 volts

V-20 { LINE: 115 volts, 50 to 60 cycles
LOAD: 0-115 volts

V-20H { LINE: 115 volts, 50 to 60 cycles
LOAD: 0-270 volts

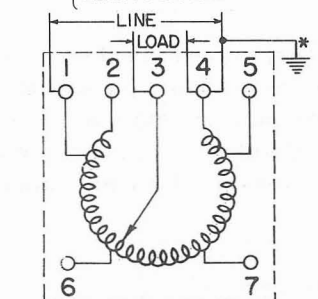

Figure 7

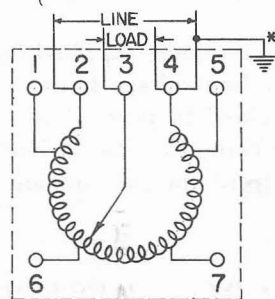

Figure 8

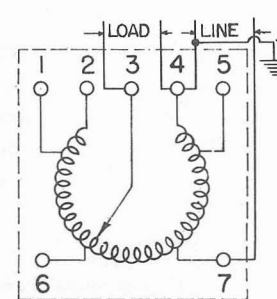

Figure 9

PANEL MOUNTING

PANEL MOUNTING

*If ground is necessary, common line-load terminal must connect to ground side of line.

OPERATING AND SERVICE NOTES

1. Be sure voltage and frequency are correct before connecting Variac to line. The Variac is a transformer and will not operate on a d-c circuit.
2. When using overvoltage circuit (Figures 4, 6, 7, 9) be sure connected load will stand overvoltage.
3. Protective devices are cheaper than Variacs. In many cases on steady predictable loads, fuse protection will be entirely adequate. Where short-term overloads are to be handled (as in motor starting or lamp inrush) a time-current integrating breaker, such as the Heine-mann No. 0411TS, of the proper current rating is more effective.
4. Always set Variac to zero before switching to avoid surge damage. This is particularly important with lamp loads. The ratio of hot to cold resistance of modern incandescent lamps may be as great as 15:1. *Instantaneous brush current should never exceed 10 times rated current.*
5. Clean brush track with a soft cloth and safe solvent (alcohol or naphtha). Do not use abrasives — they might destroy the stabilized track surface.
6. **BRUSHES** When ordering replacement brushes for the V-20 Variac, specify the General Radio Company Type VBT-5 (formerly V20-302) for a set of two; for the V-20H Variac, specify the General Radio Company Type VBT-2-2 (formerly V20-303) for a set of two. Brushes may be removed from the radiator by simply rotating the top plate so that it clears the retaining pins. In addition V-20 and V-20H brushes are supplied with pigtailed. Pigtailed attach and detach by means of button head screws on the radiator "nose." Proper brush insertion is indicated by a slight click or detent action as the long

axis of the top plate aligns with the retaining pins. Newly installed, or reinstalled, brushes must be seated for proper Variac operation. *With power off*, a few swings of the brush over the abrasive side of a piece of crocus cloth resting on the brush track will effectively mate brush and track. Remove the crocus cloth and blow or brush loose carbon from the brush track before applying power.

Brush extension is purposely limited to prevent contact between metal brush shell and Variac winding, avoiding short-circuits. Operation of a brush beyond its extension limit causes arcing and high resistance, indicated by high output voltage drop under load. Replace brushes before this limit is reached. Excessive load current accelerates brush deterioration and damages windings. Rapid brush failure is a sure sign of overload.

7. Broken terminal strips may be removed and replaced with no other tool than a screw-driver. While every effort has been made to reduce terminal-strip breakage by the use of high impact strength material and a metal terminal cover, accidents will happen.

8. When returning Variacs for repairs, or for any other reason, please request shipping instructions from our Service Department. Also please state type number of instrument and date of purchase. Type numbers of V-20 Variacs appear on the terminal strip and dial.

9. If you feel that your Variac does not operate satisfactorily, write to our Service Department, explaining in detail the conditions of operation. Enclose a diagram of your circuit with input and output voltages and currents indicated, and specify type of load and rating.

ADDITIONAL INFORMATION ON VARIACS

Variacs have certain inherent characteristics, which, if known and used, greatly extend their usefulness under certain circuit conditions. A discussion of such circuit conditions and recommended practice is here furnished so that you may realize the full potentiality of your Variac.

1. **FIXED LOAD OPERATION** is the most commonly encountered Variac application. Under this condition full advantage may be taken of the *maximum current rating* obtained at line voltage. The optimum load may be determined from the formula:

$$\text{Min. load impedance} = \frac{\text{Line volts}}{\text{Maximum output amperes}}$$

For a load of this or greater impedance, load current will never exceed allowable current, if the Variac is connected to *omit the over-voltage feature*.

2. **LIMITED RANGE OPERATION**, either for low voltage circuits, or for line voltage regulation is another common Variac application. The Variac is, fundamentally, a wide range instrument, and its confinement to a limited range unnecessarily sacrifices this feature. The use of a supplementary transformer under such conditions offers many advantages. These are:

- (a) Increased current capacity in the ratio of line voltage to operating range.
- (b) Finer adjustment, since range is spread over whole Variac dial.
- (c) Improved Variac life as brush traverses entire winding to cover operating range, instead of repeatedly traversing a limited arc.

For simplicity, the discussion will be confined to Variacs operating from a nominal 115-volt line, but, it will be

understood that the same argument applies for 230-volt Variacs.

(1) Consider an output range of 0 to 10 volts. Since the ratio of line volts (115) to load volts (10) is 11.5, the increase in current from the use of a proper supplementary transformer is 11.5 to 1. The transformer should have a voltampere capacity equal to that of the Variac (Line voltage x maximum amperes) and should be connected as shown in Fig. (a).

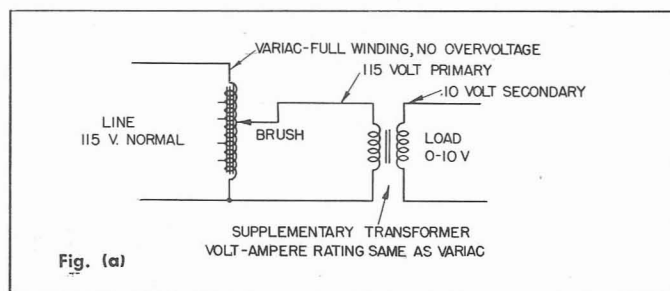

(2) Consider a line voltage range of 105 to 125 volts requiring adjustment to a nominal 115 volts. Line volt to load range is $\frac{115}{125-105} = 5.75$, indicating an increase in load current of 5.75 to 1. In this case the volt-ampere capacity of the supplementary transformer need only

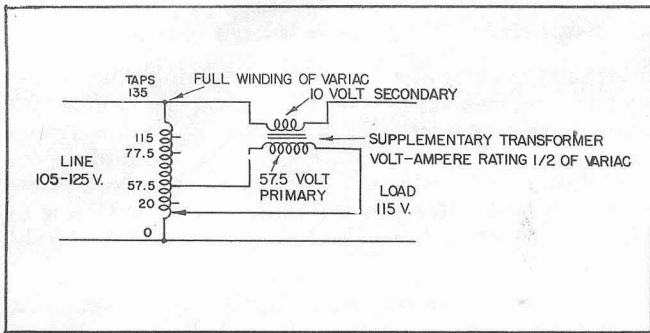

Fig. (b)

be one half that of the Variac, because of the plus and minus nature of the range. Fig. (b) shows the circuit. Other values, of course, may be employed, but the examples shown are typical. Note the enormous increase in current capacity, case (1) yielding 11.5 times, and case (2) 5.75 times the Variac rating. In addition, case (1) permits insulated isolation of the load.

3. HIGH VOLTAGE OPERATION above normal Variac ratings may be accomplished by ganging two standard Variacs in the circuit of Fig. (c).

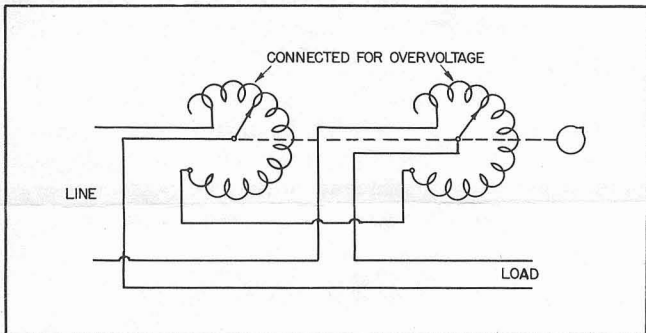

Fig. (c)

This circuit shown permits doubling of standard voltage ratings with current ratings unchanged. Thus 230-

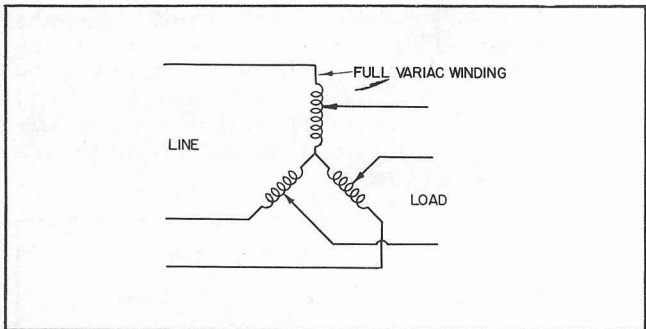

Fig. (d)

volt models may be used at 460 volts, 115-volt models at 230 volts. **CAUTION:** Load must not be grounded.

4. THREE-PHASE OPERATION of Variacs again introduces an inherent advantage in the "Y" connection illustrated in Fig. (d). Because of the overvoltage winding of Variacs, a 3-gang "Y" assembly will operate at twice nominal line voltage. Thus standard 0 — 135-volt units can operate at 230 volts; 0 — 270-volt units operate at 460 volts. This actually means that the KVA rating for a 3-phase "Y" is 3.52 times the single phase rating of an individual Variac of the type ganged, instead of 3 times.

Open "Δ" connections, however, while not yielding a rating gain, permit overvoltage as shown in Fig. (e), or may be operated to line voltage only.

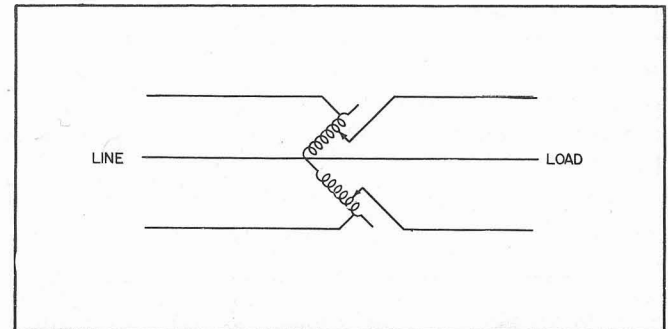

Fig. (e)

5. PARALLEL OPERATION OF VARIACS is not recommended, except in the case of the largest units, as it is better to use a single unit of the next larger size. When units are connected in parallel, it is essential that a choke be connected as shown in Fig. (f), to limit circulatory currents and unbalance. In many 230-volt applications the connection of two 115-volt units as

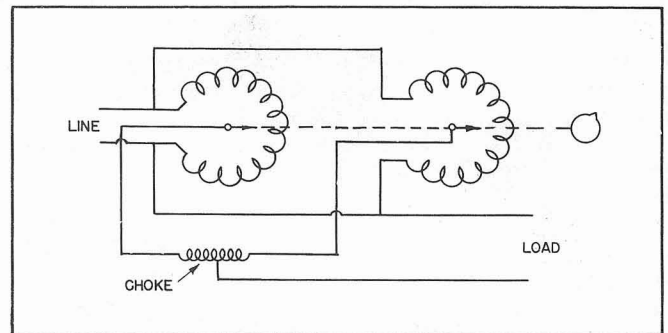

Fig. (f)

shown under "3." (High-Voltage Operation) is better than parallel operation and will, in most cases, yield more power.

GENERAL RADIO COMPANY

275 MASSACHUSETTS AVENUE
CAMBRIDGE 39 MASSACHUSETTS

NEW YORK: Broad Avenue at Linden
Ridgefield, New Jersey

LOS ANGELES: 1000 North Seward Street
Los Angeles 38, California

WASHINGTON: 8055 13th Street
Silver Spring, Maryland

CHICAGO: 920 South Michigan Avenue
Chicago 5, Illinois

SAN FRANCISCO: 1182 Los Altos Avenue
Los Altos, California

PHILADELPHIA: 1150 York Road
Abington, Pennsylvania

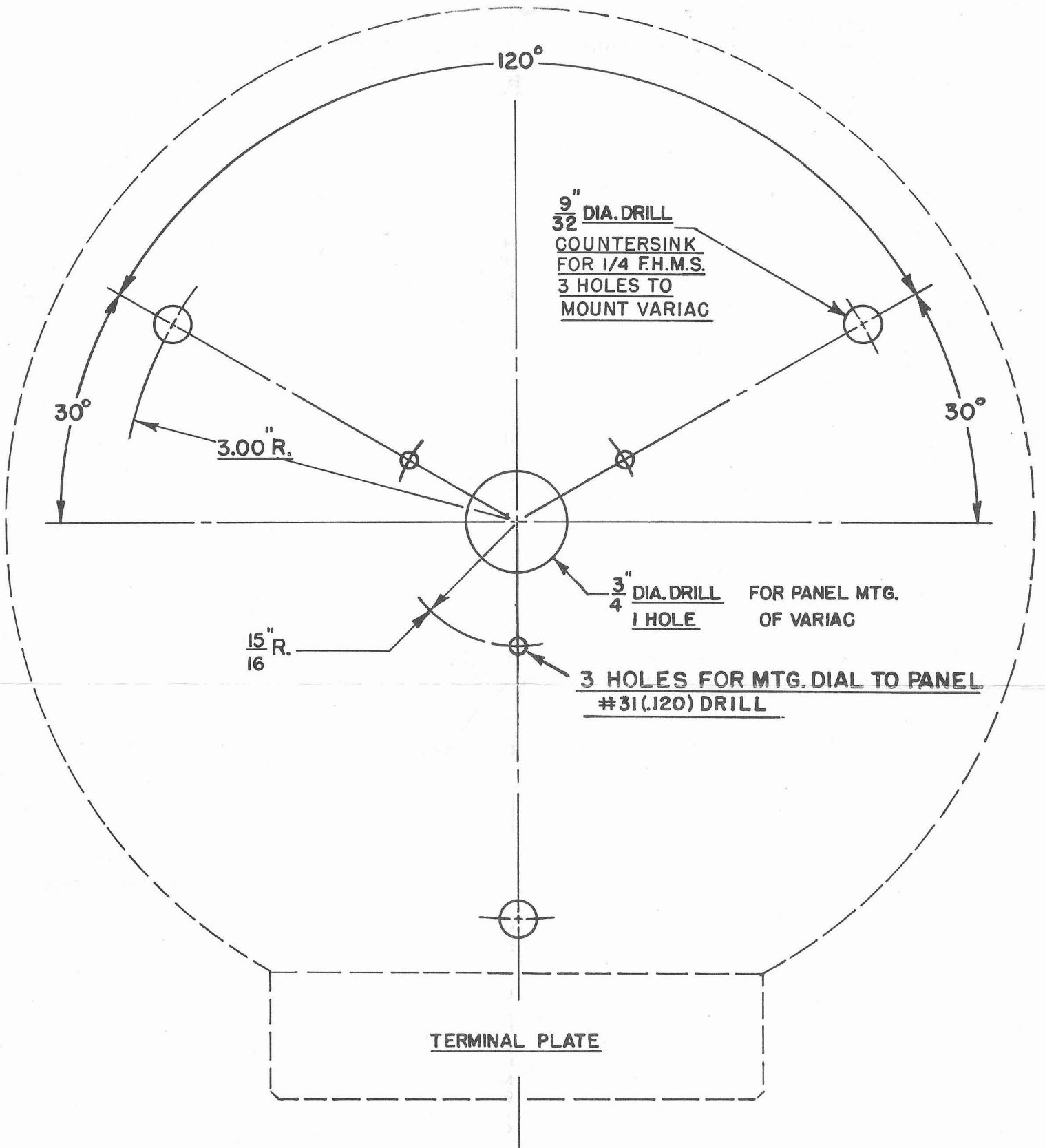

DRILLING TEMPLATE
 FOR
V-20 VARIACS.